

Beyond Conventional Lithography

Made in Germany – Europe



All-in-1 Solution for Transforming Design Ideas into Industrial Manufacturing
for 21st Century Applications

Conventional Lithography

Mask Aligner

UV-assisted Replication/NIL

Projection

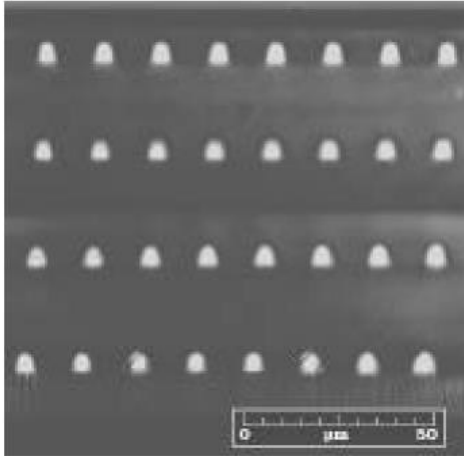

THALES
AIRBORNE SYSTEMS

Fraunhofer
ISC

Fraunhofer
IOF

①

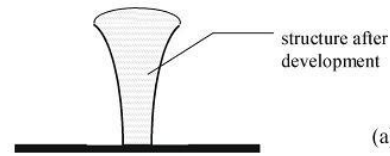
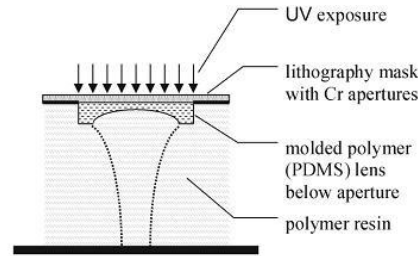

(a)

③

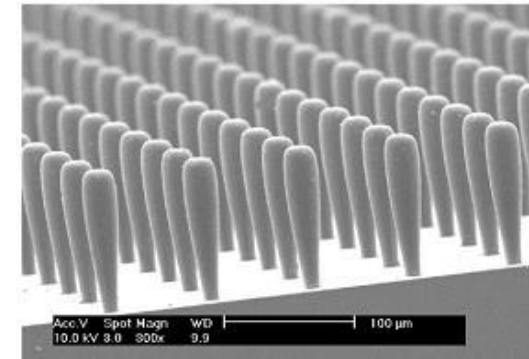

Loss variation < 0.05 dB (horizontally)
0.08 dB (vertically) direction in the stack

Fraunhofer
ISC

Fraunhofer
IOF

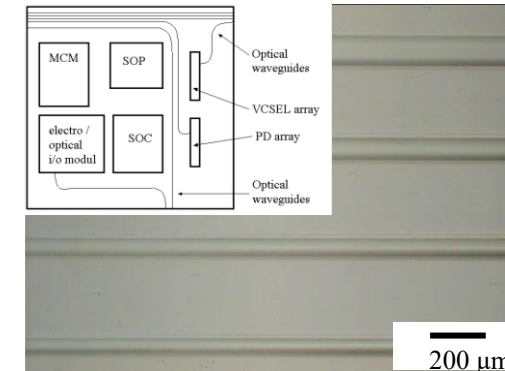

200 μm

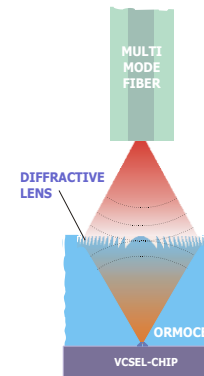
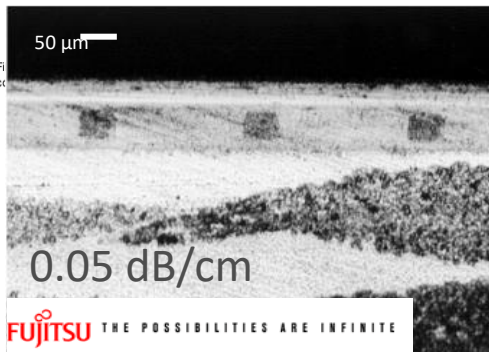
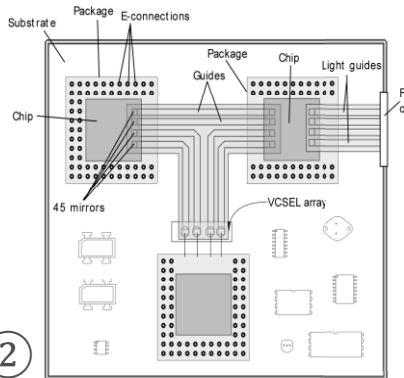

csem
Swiss Center for Electronics and Microtechnology

micro resist
technology

②



③

Fraunhofer
ISC

Beyond Conventional Lithography – Embedding 3D Litho

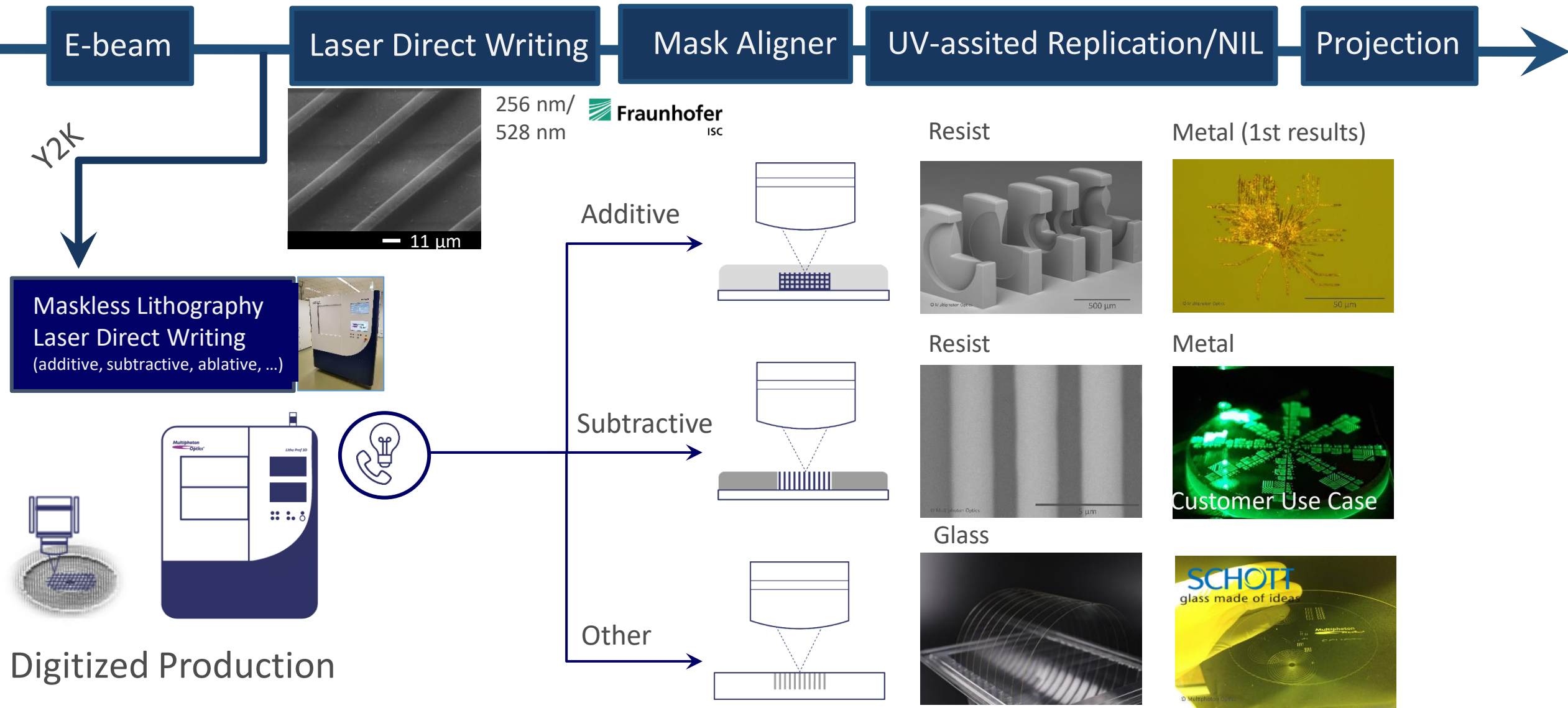

Beyond Conventional Litho – Special Features of 3D Litho



Ultraflat Optics

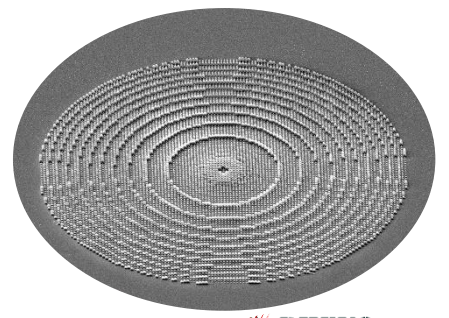

$D \approx 1.1 \mu\text{m}$ PHENOMENON

Wafer Level Optics

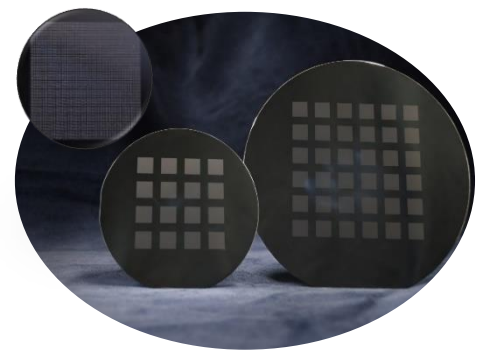

6" (ex.)

Extreme Aspect Ratio

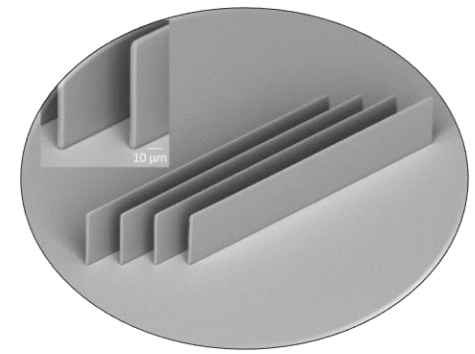

16:1 (ex.) ...43:1

Lean Processes

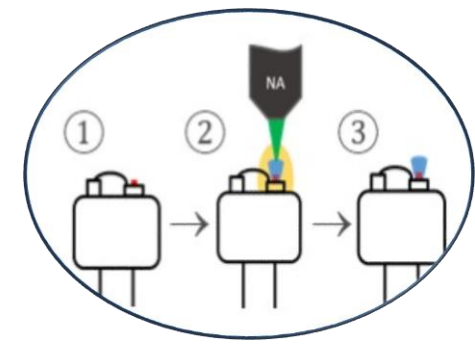

#3

Automation

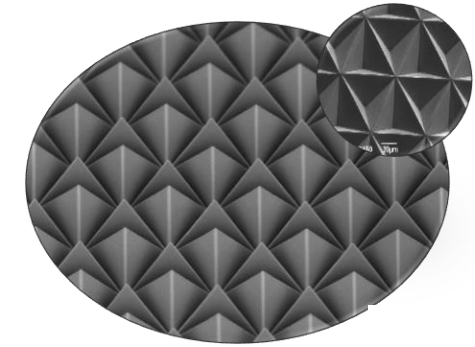

24/7

3D Optical Interconnects

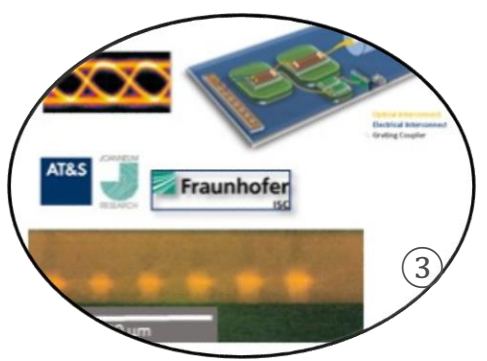

High Throughput

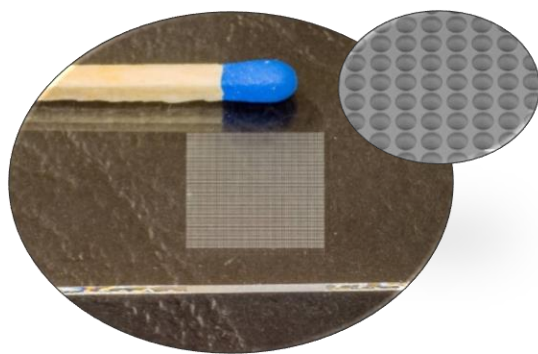

> 1 – 5 s/lens (ex.)

Upscale



> 1 cm

Arbitrary Substrates

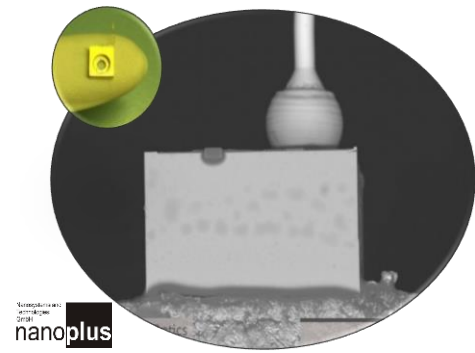

Resolution

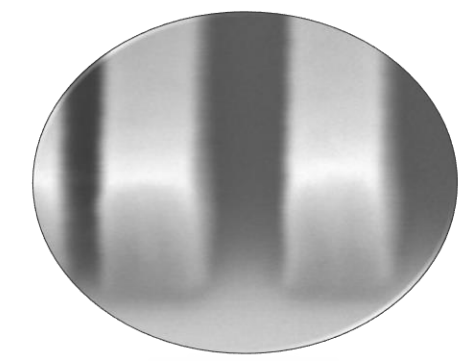

≤ 250 nm